



In-Wall  
Mounting Kit  
with Grille

## CK29 Installation Guide

## Important Information

**Caution:** The XRT29 /XRT30 High Frequency Column weight is 82 pounds (37.20kg) net. It requires two or more persons to safely handle.

## Installation

The XRT29/XRT30 Column Loudspeaker System requires two or more persons to safely handle the Column during assembly and placement. If the CK29 In-Wall Mounting Kit with Grille is for installing an unboxed XRT29/XRT30 Column, proceed to “Unpacking the Column” step number 13. When the XRT29/XRT30 Column location is changing from an On-wall to an In-wall Mounted Installation proceed to “Removing the Column from the Wall” step number 1. If the XRT29/XRT30 Column is currently attached to the ST29 Column Base, proceed to “Removing the Column from the Base” step number 8.

It is recommended that the Professionals at your McIntosh Dealer, who are skilled in all aspects of installation and operation, install the XRT29/XRT30 Loudspeaker System and any associated audio equipment.

### Removing the Column from the Wall

1. Carefully remove the XRT29/XRT30 Loudspeaker Grille from the Column and place it in a safe location.
2. Remove the long Locking Screw from the Wall Mounting Bracket located at the top of the XRT29/XRT30 Column. Refer to figures 1 and 3.
3. Remove the XRT29/XRT30 Column from the wall by grasping both sides of the Column and lifting first straight up about six inches, then away from the wall.
4. Temporarily set the Bottom of the Column on the floor and disconnect the hookup cables.
5. Place the XRT29/XRT30 Column on the shipping carton, if still available, or on another suitable object so the Column is about a foot off the floor.
6. Using the supplied Allen Wrench remove the Mounting Bracket from the top of the Column by removing the screw. Install one screw (1/4 x 20 inch Flat Head) into the opening at each end of the Column.

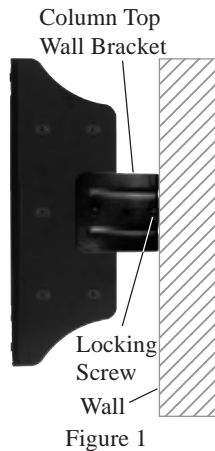

Figure 1

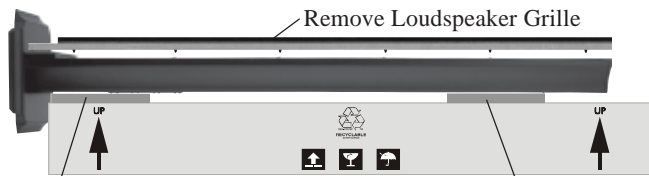

Figure 2



Figure 5

*Note:* This is very important to prevent air leaks from the Column Enclosure. Remove the two remaining brackets from the wall and save the three brackets and mounting screws for possible future use.

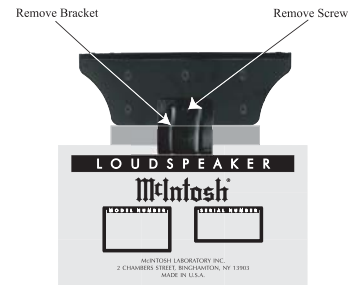

Figure 3

7. Proceed to “Installing the Loudspeaker Column” step number 20.

### Removing the Column from the Base

8. If the XRT29/XRT30 Column’s original shipping carton is available, place the Loudspeaker Column on top of the packing material located on top of the shipping carton aligning the Column Bottom End (the Glass Name Plate end) to the end of the shipping carton. If the carton is not available choose a suitable object that will place the Loudspeaker Column at least one foot (30.48cm) off the floor. Refer to figure 2.
  9. Carefully remove the Grille from the Column and store it in a safe location for possible future use. Refer to figure 2.
  10. Remove the four machine bolts and washers from the bottom of the Column Base. Refer to figure 5.
- Note:* Retain the Column Base and hardware for possible future use.
11. Using the supplied Allen Wrench and Screws, install two screws (1/4 x 20 inch Flat Head) into each side of the Column Bottom. Refer to figure 4.
- Note:* This is very important to prevent air leaks from the Column Enclosure.
12. Proceed to “Installing the Loudspeaker Column” step number 20.



Figure 4

### Unpacking the Column

13. Remove the banding material from the shipping carton. Refer to figure 6.
14. Lift off the top of the shipping carton and set it aside.
15. Lift up on the rear of the Column Loudspeaker, near the foam packing material at both ends. Place the entire assembly (Column, Loudspeaker Grille and foam packing material) next to the bottom shipping carton on a flat surface. Refer to figure 7.
16. Release the Loudspeaker Grille from the packing material by opening the slit in the packing material located on the top center. Store the Loudspeaker Grille in a safe location for possible future use.
17. In a similar manner, lift out the Loudspeaker Column and set it aside.
18. Replace the shipping carton top onto the shipping carton bottom. Take the two center pieces of the just removed packing material and lay it down flat onto the top of the shipping carton.
19. Carefully remove the protective shipping bag(s) from the Loudspeaker Column so as not to mar the Column Finish or damage the Loudspeaker Drivers.

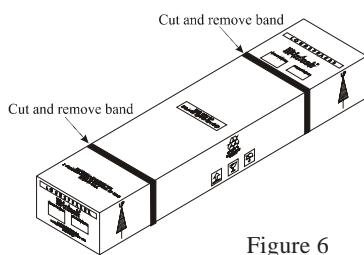

Figure 6

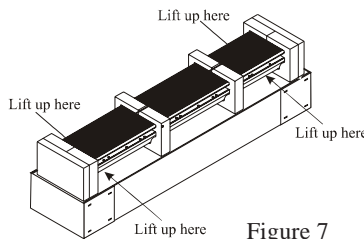

Figure 7

### Installing the Loudspeaker Column

20. Place the Loudspeaker Column on top of the packing material located on top of the shipping carton making sure to align the Column Bottom End (the Glass Name Plate end) to the end of the shipping carton. Refer to figure 5.

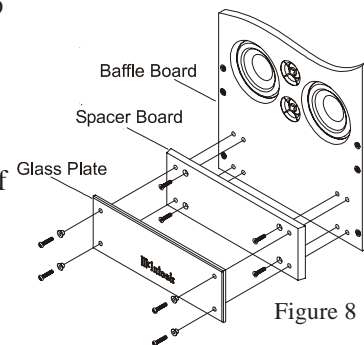

Figure 8



Figure 9

21. Using the supplied Allen Wrench, remove the Glass Plate and Spacer Board from the front bottom of the Loudspeaker Column. Refer to figure 8.

*Note: Save the Glass Plate, Spacer Board and four flat head screws for possible future use.*

22. Install eight round head screws (four from the just removed Glass Panel and four additionally supplied) into the openings on the bottom front of the Loudspeaker Column.
23. Rotate the Loudspeaker Column face down on top of the packing material. Refer to figure 9.
24. Remove and set aside the twenty screws from the rear of the Loudspeaker Column. Refer to figure 10.
25. At the locations where the just removed screws came from, attach the five In-Wall Brackets to the rear of the Loudspeaker Column. Refer to figure 11.

Screw location



Figure 10

Bracket location



Figure 11

## Installation, con't

The XRT30 High Frequency Column's Smooth Frequency Response may be altered by large object(s) located in sound waves path or by locating the column too close to a side wall. There should be an unobstructed area in front of the column of at least 30 degrees either side from the center axis for the best performance. Refer to figure 12

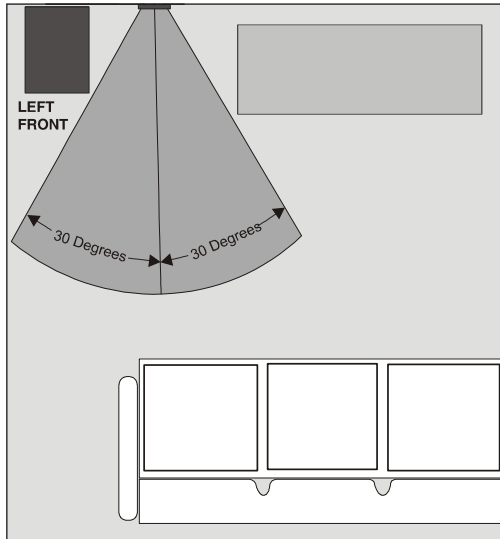

Figure 12

26. Use a suitable wall stud finder and metal detector to verify a proper

mounting location for the Column Loudspeaker before cutting the opening into the wall. The CK29 is designed for attaching to wall studs with 16 inch (40.64cm) centers.

*Note: Make sure there are no Plumbing Pipes, AC Electrical Wiring or Heating/Cooling Ductwork in the wall between the studs where the Loudspeaker Column is to be mounted.*

27. Cut an opening of 76-1/4" (193.7cm) high by 14-1/2" (36.8cm) wide into the wall.
28. Referring to the XRT29 or XRT30 Owner's Manual, make the necessary connections to the rear of the Loudspeaker Column.
29. Using the attached brackets as handles, lift up the Loudspeaker Column and place it into the wall cut-out.
30. Secure the Loudspeaker Column Brackets through the wall finish material and into the studs, using the supplied 10 x 2-1/2 inch screws. Refer to figure 13.
31. Attach the supplied McIntosh Logo to either the bottom front of the Loudspeaker Grille or on the front baffle board behind the Grille.
32. Orient the Loudspeaker Grille even with top/sides of the Column and align the Grille fastening pins to the Column Grommets (there are six pins on each side). Carefully push down to secure the Grille to the Column.

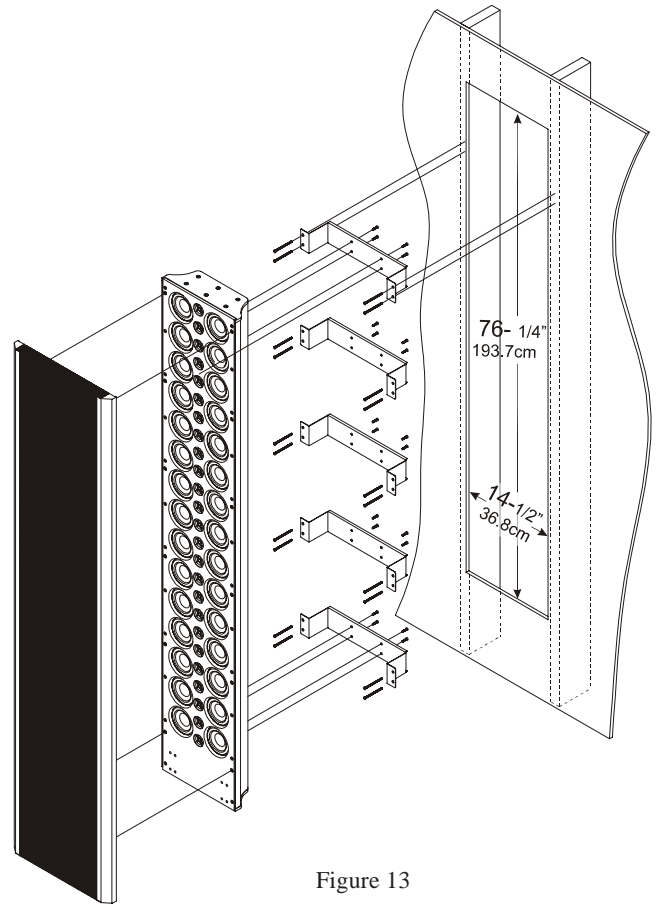

Figure 13



McIntosh Laboratory, Inc.  
2 Chambers Street  
Binghamton, NY 13903

The continuous improvement of its products is the policy of McIntosh Laboratory Incorporated who reserve the right to improve design without notice.

Printed in the U.S.A.